

# SERVICE-MANUAL

NEA ROOM CONTROLLER 230V / 24V

---



# SERVICE-MANUAL

ROOM TEMPERATURE CONTROLLER NEA 230V / 24V

---

# SERVICE-MANUAL

## ROOM TEMPERATURE CONTROLLER NEA 230V / 24V

---

### TABLE OF CONTENTS

1 . . . . .	<b>Information and safety guidelines</b> . . . . .	<b>3</b>
2 . . . . .	<b>System description</b> . . . . .	<b>5</b>
2.1 . . . . .	System components NEA . . . . .	5
2.2 . . . . .	Functional overview . . . . .	6
2.3 . . . . .	Technical data . . . . .	7
3 . . . . .	<b>Installation</b> . . . . .	<b>10</b>
3.1 . . . . .	System structure . . . . .	10
3.2 . . . . .	Wiring of NEA H and NEA HT room controllers to NEA H 230V / 24V wiring centre . . . . .	11
3.3 . . . . .	Wiring of NEA H and NEA HT room controller without use of wiring centre . . . . .	12
3.4 . . . . .	Wiring of NEA HCT room controllers to NEA HC 24V wiring centre . . . . .	13
3.5 . . . . .	Wiring of NEA HCT room controllers without use of NEA HC 24 V wiring centre. . . . .	14
3.6 . . . . .	Use of dew point monitors . . . . .	15
3.7 . . . . .	Wiring of NEA timer to NEA wiring centre . . . . .	16
3.8 . . . . .	Wiring of a pump to NEA wiring centres with pump module . . . . .	17
4 . . . . .	<b>Parameterisation and special functions</b> . . . . .	<b>18</b>
4.1 . . . . .	Introduction . . . . .	18
4.2 . . . . .	Operating in service and expert level . . . . .	18
4.3 . . . . .	Service level . . . . .	19
4.4 . . . . .	Expert level . . . . .	21
4.5 . . . . .	Special functions . . . . .	24
5 . . . . .	<b>Error messages</b> . . . . .	<b>25</b>
6 . . . . .	<b>Troubleshooting</b> . . . . .	<b>26</b>
7 . . . . .	<b>Glossary</b> . . . . .	<b>28</b>

---

# SERVICE-MANUAL

## ROOM TEMPERATURE CONTROLLER NEA 230V / 24V

---

### 1. Information and safety guidelines

#### Validity

This service manual is valid for United Kingdom.

#### Navigation

At the beginning of this manual you will find a detailed table of contents with hierarchical headlines and the corresponding page numbers.

#### Pictograms and logos



Safety information



Legal information



Important information to be considered



---

This service manual is designed to provide additional information for experts. It is valid for room temperature controllers NEA 230V and NEA 24V in combination with the wiring centres and the other components of the control system.

**This manual is no replacement for the instruction and installation manuals which come with the units.**

For fundamental guidance concerning wiring and operating please see the instructions that come with the units. These instructions are also available for download.

---



---

#### Safety guidelines and instruction manuals

- Please read the safety guidelines and instruction manuals
- Completely prior to the start of installation for your own safety and that of others.
- Please keep hold of the manuals.
- Please contact your REHAU sales office if safety
- Guidelines or certain installation steps are not understood or are unclear.
- **Disregarding of safety guidelines might cause property damage or personal injury.**

#### Intended use

The room temperature controllers NEA and the other components of the system may only be planned, installed and operated as described

- in the documents that accompany the products
- in the current technical information
- this service manual.

Any other use is not intended and therefore not allowed.



---

Observe all applicable national and international laying, installation, accident-prevention and safety regulations when installing the system and observe the technical information notes. Areas of use not dealt with in this technical information (special applications) require consultation with our applications department. Please contact your REHAU sales office.

---

# SERVICE-MANUAL

## NEA ROOM CONTROLLER 230V / 24V

---



### Personnel requirements

- Allow only officially authorised professional companies and trained persons to assemble our systems.
- Work on electrical systems or cabling may only be performed by professional electricians trained for this purpose.

### General safety precautions

- Keep the work area clean and free of obstructions.
  - Provide sufficient lighting in the work area.
  - Keep children, house pets and unauthorised persons away from tools and the assembly sites. This is especially important in cases of renovation in inhabited areas.
  - Only use the intended components for the respective REHAU system. The use of components or tools from other companies which are not from the respective REHAU installation system can lead to accidents or other dangers.
-

# SERVICE-MANUAL

## NEA ROOM CONTROLLER 230V / 24V

---

### 2. System description

#### 2.1 System components NEA

**Room temperature controller NEA H, NEA HT und NEA HCT**  
Room temperature controller for 230V AC or 24V AC for the applications heating and heating / cooling.



Fig. 2-1 Room temperature controller NEA H, HT and HCT

#### Remote temperature probe NEA

Usable in combination with controller NEA HCT as floor temperature probe or as additional room temperature probe.



Fig. 2-2 Remote temperature probe NEA

#### Wiring centre NEA H and NEA HC

Wiring centre for room temperature controllers, actuators and timer.



Fig. 2-3 Wiring centre NEA H und NEA HC

#### Timer NEA

2-channel weekly timer.



Fig. 2-4 Timer NEA

#### Actuator

Thermal actuator with 230V AC or 24V AC supply voltage, protection class IP54

#### Transformer 50VA

Safety transformer 230 V AC/24 V AC according EN 61558, power 50 VA

# SERVICE-MANUAL

## ROOM TEMPERATURE CONTROLLER NEA 230V / 24V

---

### 2.2 Functional overview

	NEA H	NEA HT	NEA HCT
Heating	✓	✓	✓
Cooling			✓
Temperature reduction by internal time switch programme		✓	✓
Temperature reduction by external "Timer NEA" possible	✓	✓	✓
Display of current temperature	✓	✓	✓
Display of current time and weekday		✓	✓
Setting of 3 timing programmes per day		✓	✓
Party and holiday mode		✓	✓
Integrated frost and valve exercise function	✓	✓	✓
Switching of operating mode heating/cooling manually or externally			✓
Remote temperature probe connectable			✓

# SERVICE-MANUAL

## NEA ROOM CONTROLLER 230V / 24V

---

### 2.3 Technical data

#### NEA Room Controller

	NEA 230 V	NEA 24 V
Colour	Front plate white (RAL 9016); Back cover anthracite grey (RAL 7016)	
Operating voltage	230 V, AC $\pm 10\%$	24 V, AC -10% / +20%
Max. switching current	0,2 A (resistive load)	1 A (resistive load)
Fuse	T 0,63 A	T 1 A
Safety	Class II	Class III
Max. number of actuators	5 thermal actuators	
Degree of protection	IP 30	
Frost protection mode	5 °C	
Dimensions, front	88 x 88 mm	
Dimensions, rear	75 x 75 mm	
Depth	26 mm	
Storage temperature	-20 – 60 °C	
Ambient temperature	0 – 50 °C	
Application	In enclosed spaces	

#### NEA Remote temperature probe

Sensor type	NTC 10K (10 kOhm, 1 % at 25 °C)
Cable length	4 m
Protection class	IP 67

#### NEA Timer

Operating voltage	230 V AC
Number of memory locations	84
Power reserve	10 years

---

# SERVICE-MANUAL

## NEA ROOM CONTROLLER 230V / 24V

### NEA wiring centre

	NEA wiring centre 230 V Heating	NEA wiring centre 24 V Heating, Heating und Cooling
Colour	Lower housing and head section: dark grey similar RAL 7021; cover: light grey similar RAL 7035	
Operating voltage	230 V, AC	24 V, AC *)
Switch contact of pump relay **)	Potential free, relay, 230 V AC: 5A; 24 V DC: 1A	
Fuse	T 4 A H	T 2 A
Safety	Class II	Class III
Maximum number of controllers	6	
Max. number of actuators	12 thermal actuators	
Number of terminals for timing programmes ***)	2	
Degree of protection	IP 20	
Frost protection	5 °C	
Dimensions, H x W x L	74 mm x 40 mm x 300 mm	
Ambient temperature	0 – 60 °C	
Humidity	Max. 80%, non-condensing	
Application	In enclosed spaces	

\*) Transformer 50 VA for supply needed

\*\*) only variant with pump relay

\*\*\*) NEA Timer needed

### Transformer 50 VA

Operating voltage	230 V AC
Output voltage	24 V AC
Power	50 VA
Dimensions W x H x D	68 mm x 70 mm x 75 mm
Other technical data	Safety transformer according EN 61558 Conditionally short-circuit proof with integrated overheating protection Connecting cable (primary side) with moulded-in plug, length 100 cm Cable on secondary side 30 cm Mounting plate included, with clips for mounting rail



# SERVICE-MANUAL

## NEA ROOM CONTROLLER 230V / 24V

---

### Actuator

	Actuator 230 V	Actuator 24 V
Operating voltage	230 V, AC +10%... -10%, 50/60 Hz	24 V, AC, +20% ... - 10%, 0 - 60 Hz
Inrush current	300 mA for max. 200 ms	250 mA for max. 2 min
Operating power		1,8 W
Version		Normally closed (NC)
Closing and opening times		approx. 3 min
Actuator travel		4 mm
Actuator power		100 N $\pm$ 5 %
Ambient temperature		0 .... 60°C
Degree / class of protection		IP 54/II
Housing		Polyamide / grey
Connecting cable		2 x 0,75 mm <sup>2</sup> , 1 m
Dimensions W x H x D		44 mm x 58 mm x 47 mm

# SERVICE-MANUAL

## NEA ROOM CONTROLLER 230V / 24V

### 3. Installation

#### 3.1 System structure

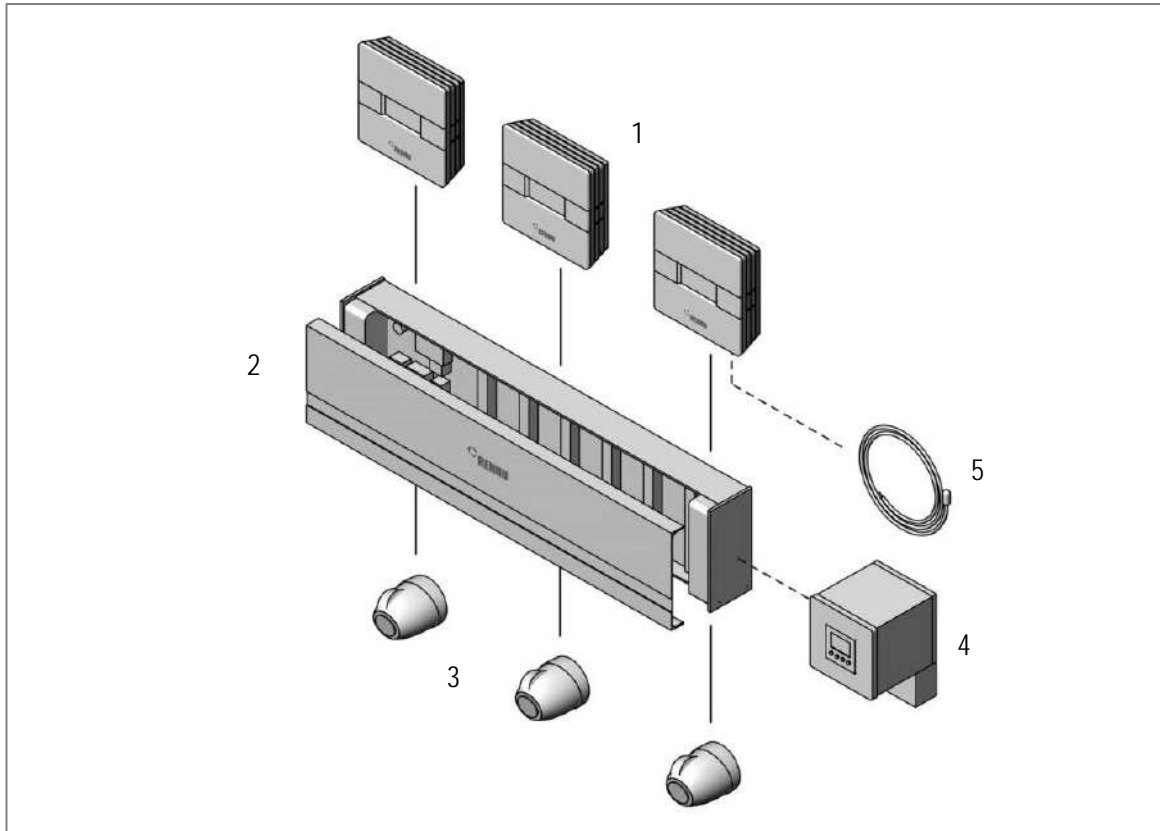

Fig. 3-1 System structure NEA control system

- 1 - NEA room controller
- 2 - NEA Wiring centre
- 3 - Actuators
- 4 - Timer
- 5 - Remote temperature probe

The NEA room controller, the thermal actuators and the optional timer are connected to the NEA wiring centre.

The NEA wiring centre offers a safe and clear wiring of the system in the manifold cabinet.

The wiring centre allows up to 6 room temperature controllers and a maximum number of 12 actuators to be connected.

For the central control of the setback times the NEA timer can be used as an option.

A remote temperature probe can be connected to the NEA HCT room controllers.



**Only wiring centres NEA HC and room temperature controllers NEA HCT may be used in heating/cooling applications!**

**A mixed use of room temperature controllers NEA HCT together with room temperature controllers NEA H or HT is not possible!**

# SERVICE-MANUAL

## NEA ROOM CONTROLLER 230V / 24V

### 3.2 Wiring of NEA H and NEA HT room controllers to NEA H 230 V / 24 V wiring centre

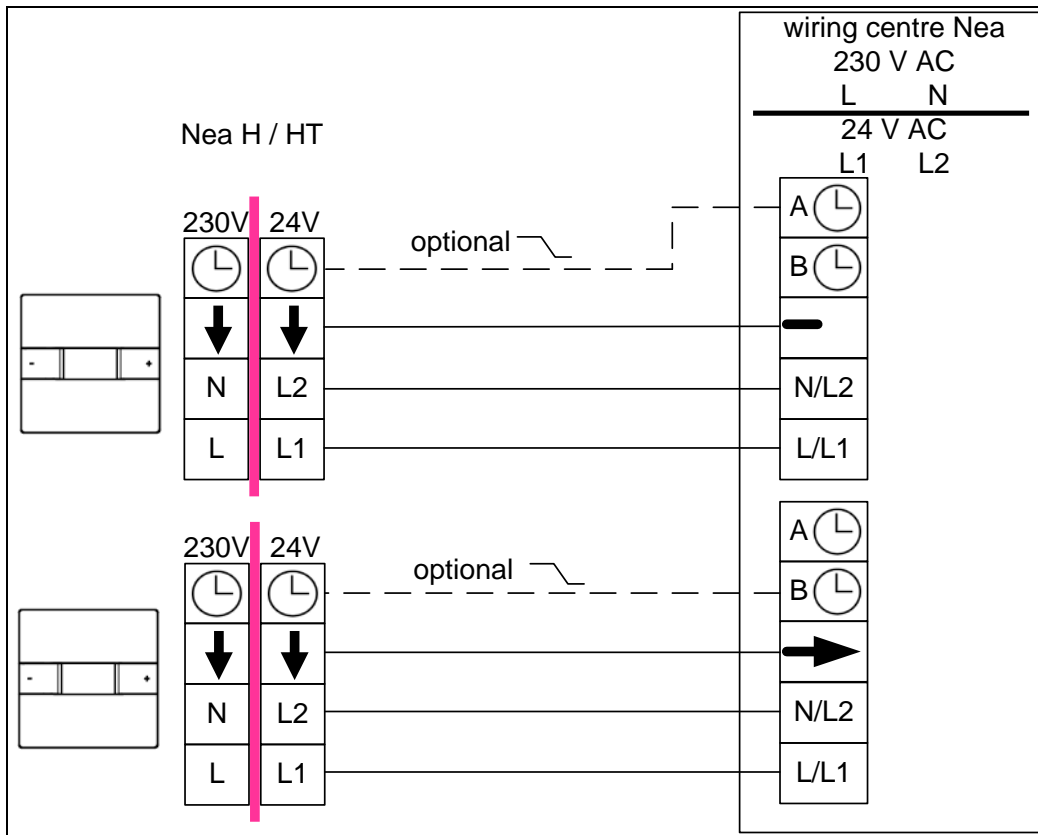

Fig. 3-2 Wiring of NEA H and NEA HT room controllers to NEA H 230 V / 24 V wiring centre

**Comment:**

The connection of the reduced mode signal (clock symbol) is optional. The NEA wiring centre provides 2 time switch signals (A and B). Each controller can be assigned to one of the time switch signals. The time switch signals of the wiring centre are generated by NEA timer (2-channel weekly timer).

**Triggering of reduced mode (Energy saving):**

**NEA H:**

The external time switch signal is only valid, when the operating mode "time switch programme" is activated by the control buttons on the controller. When the controller is in normal operating mode or in reduced operating mode, the external signal is void.

**NEA HT:**

The same for NEA H room controller is valid, but in operating mode "time switch programme" the mode (normal/reduced) defined by the internal time switch programme is overwritten by the external signal (Force of reduced mode). See also parameter PE20.

# SERVICE-MANUAL

## NEA ROOM CONTROLLER 230V / 24V

### 3.3 Wiring of NEA H and NEA HT room controller without use of wiring centre

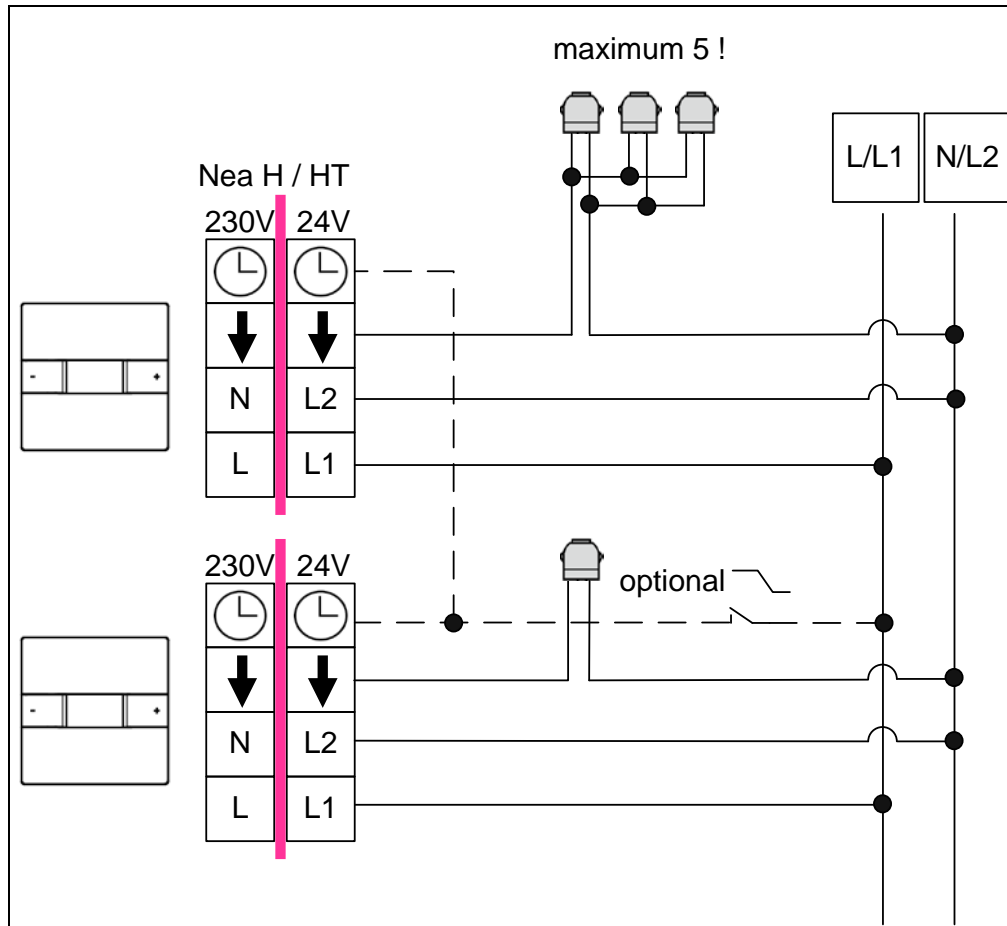

Fig. 3-3 Wiring of NEA H and NEA HT room controller without use of wiring centre

#### Note:

The signal for reduced mode has to be potential L (230V-systems) or L1 (24V-systems).

The signal may be generated by a timer or by a switching contact (common or for each separate controller).



In installations with more than one feed-in of operating voltage (e.g. several manifolds and therefore several wiring centres) phase equality must be observed as soon as there is any electrical connection between the groups of control systems!

# SERVICE-MANUAL

## NEA ROOM CONTROLLER 230V / 24V

### 3.4 Wiring of NEA HCT room controllers to NEA HC 24 V wiring centre

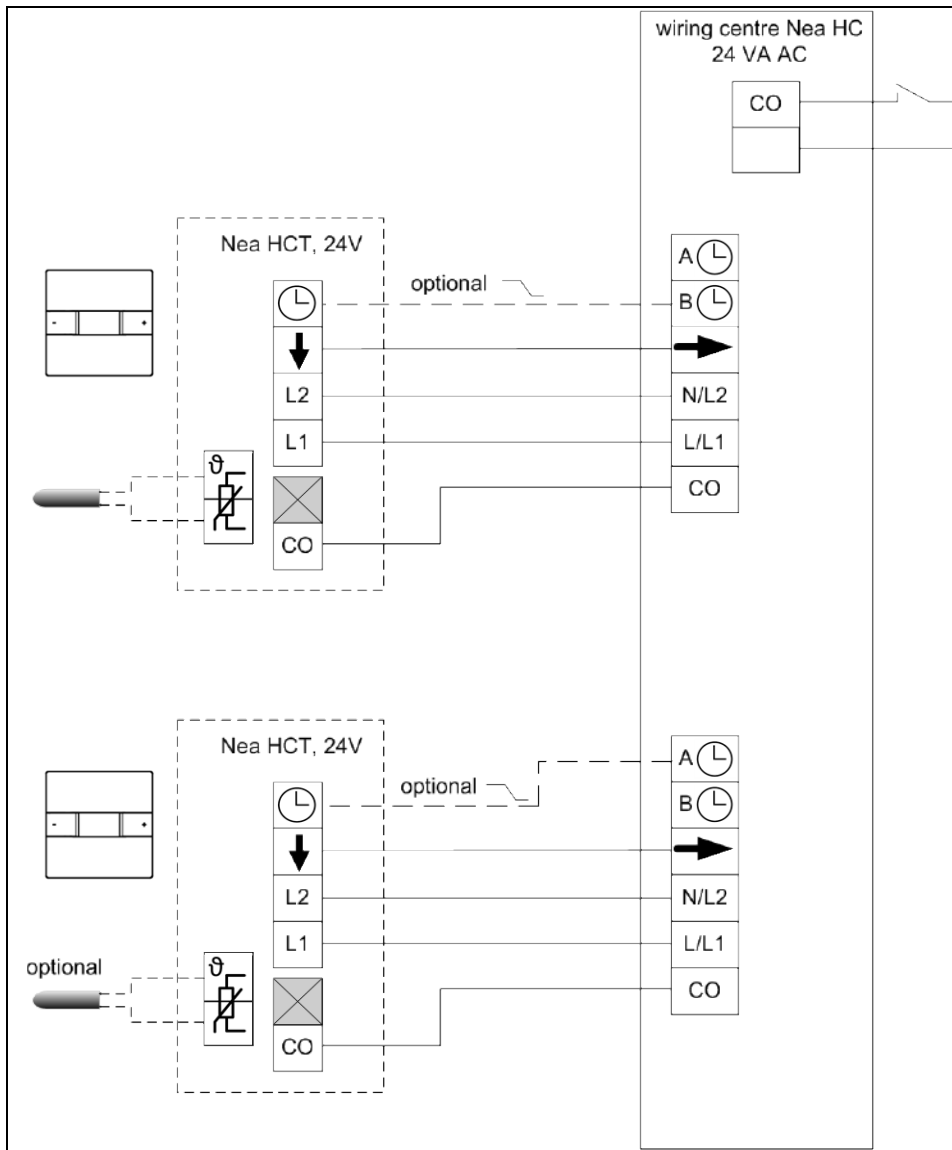

Fig. 3-4 Wiring of NEA HCT room temperature controller to NEA HC 24 V wiring centre

Comment:

The CO signal is generated inside the wiring centre. As soon as the external switch connected to the shown pair of terminals is closed, the connected controllers change to cooling mode.



Controllers which are not allowed to change to cooling mode (e.g. in bath rooms) have to be connected in the same way as shown in the wiring diagram. Blocking of cooling mode is done by parameter PE9.

**It is not provided to connect NEA H or NEA HT room controllers to a NEA HC 24V wiring centre. These controllers are only designed for installations with solely heating mode and would have to be blocked in cooling mode by additional actions.**

# SERVICE-MANUAL

## NEA ROOM CONTROLLER 230V / 24V

### 3.5 Wiring of NEA HCT room controllers without use of NEA HC 24 V wiring centre

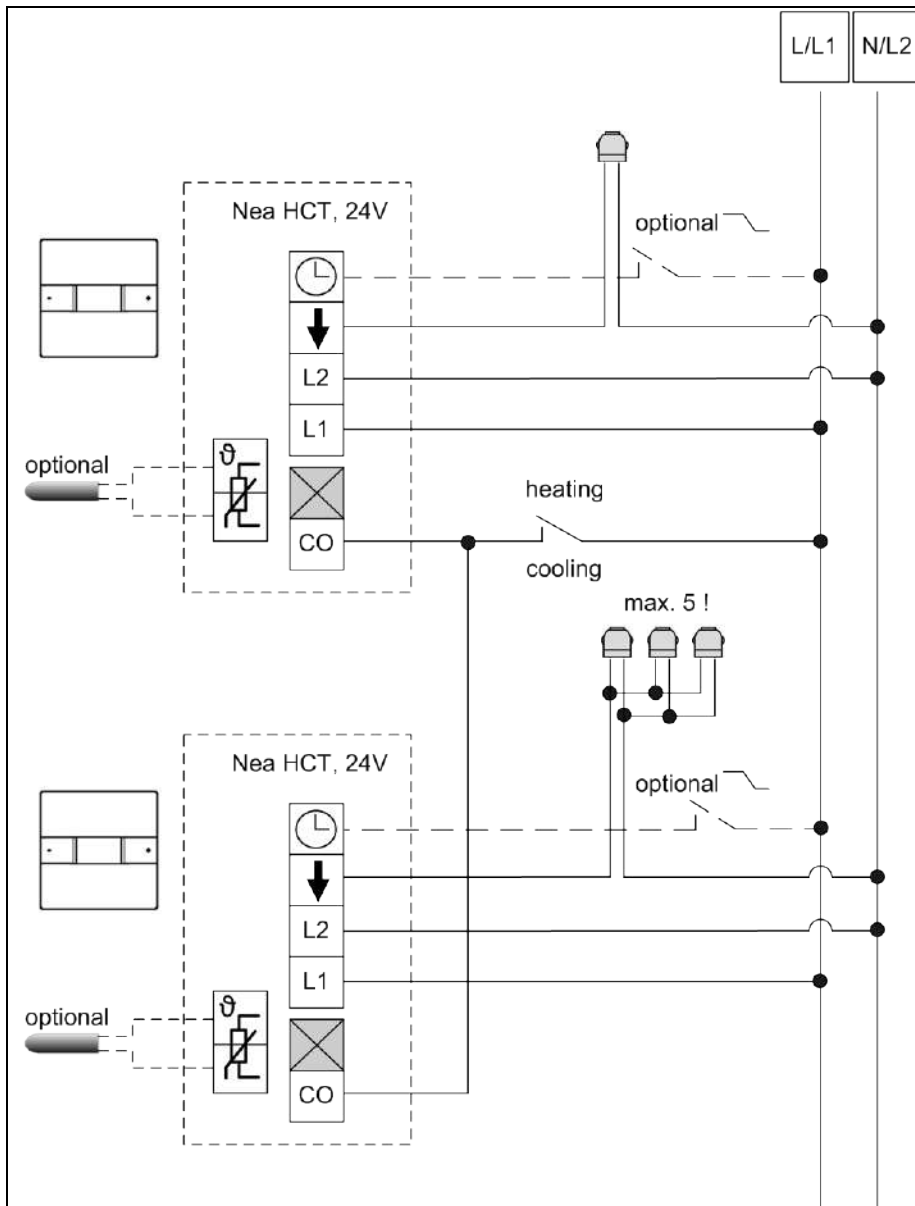

Fig. 3-5 Wiring of NEA HCT room controllers without use of NEA HC 24 V wiring centre

#### Comment:

The signal for reduced mode and the signal for cooling mode have to be potential L1.  
 The signal for reduced mode may be generated by a timer or by a switching contact (common or for each controller separate).



In installations with more than one feed-in of operating voltage (e.g. several manifolds and therefore several wiring centres) phase equality must be observed as soon as there is any electrical connection between the groups of control systems!

# SERVICE-MANUAL

## NEA ROOM CONTROLLER 230V / 24V

### 3.6 Use of dew point monitors

Dew point monitors must be fixed at the coldest point of the flow pipe. Ensure that the dew point monitor (DPM) is in sufficient contact with the ambient air.

The DPM is installed as an opening contact in the line to the actuators, so that the activation is interrupted in case of condensation.

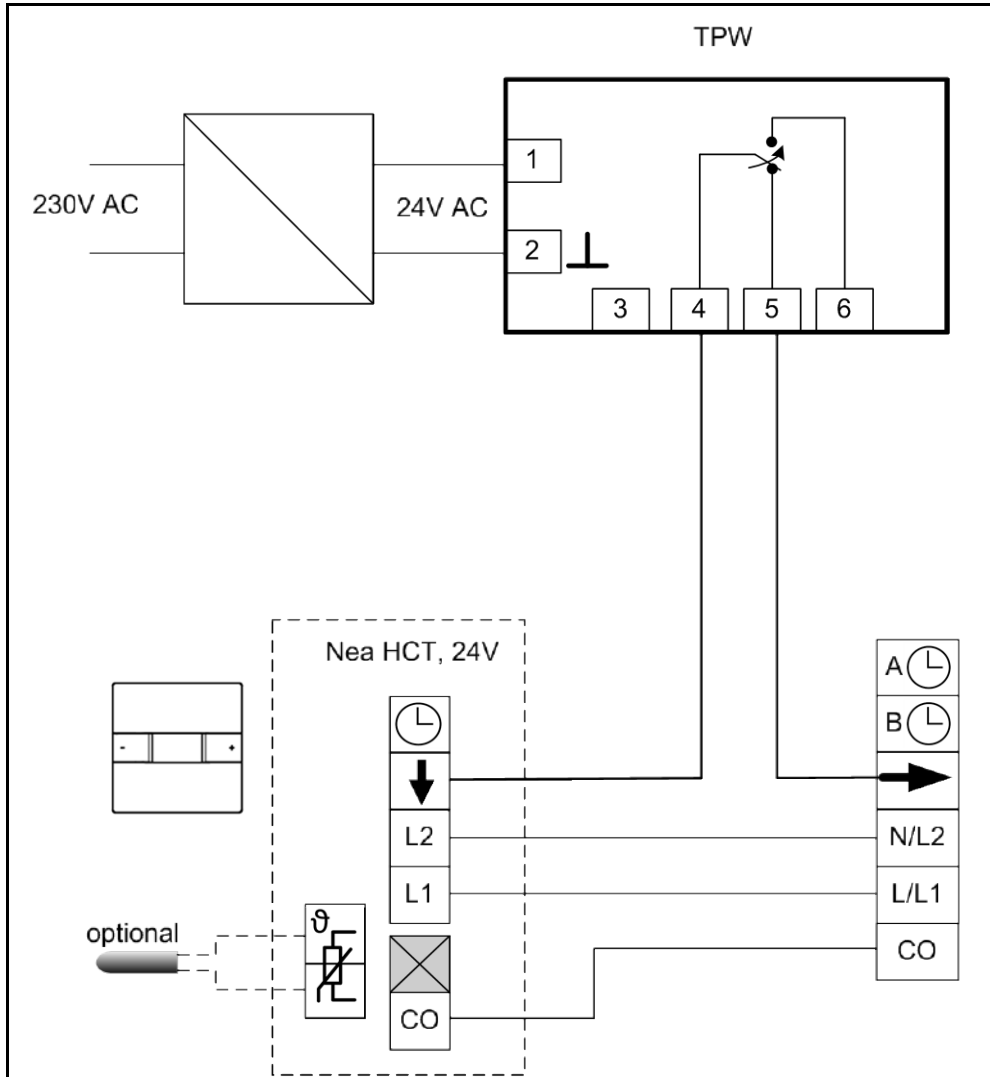

Fig. 3-6 Use of dew point monitors

**Comment:**

The diagram shows the dew point monitor TPW.

The maximum power consumption of the TPW is 1 VA; because of this the power supply 24 V of the wiring centre can be used.

The switching capacity of the TPW is 24V, 1A, and therefore sufficient for 5 actuators.

# SERVICE-MANUAL

## NEA ROOM CONTROLLER 230V / 24V

### 3.7 Wiring of NEA timer to NEA wiring centre

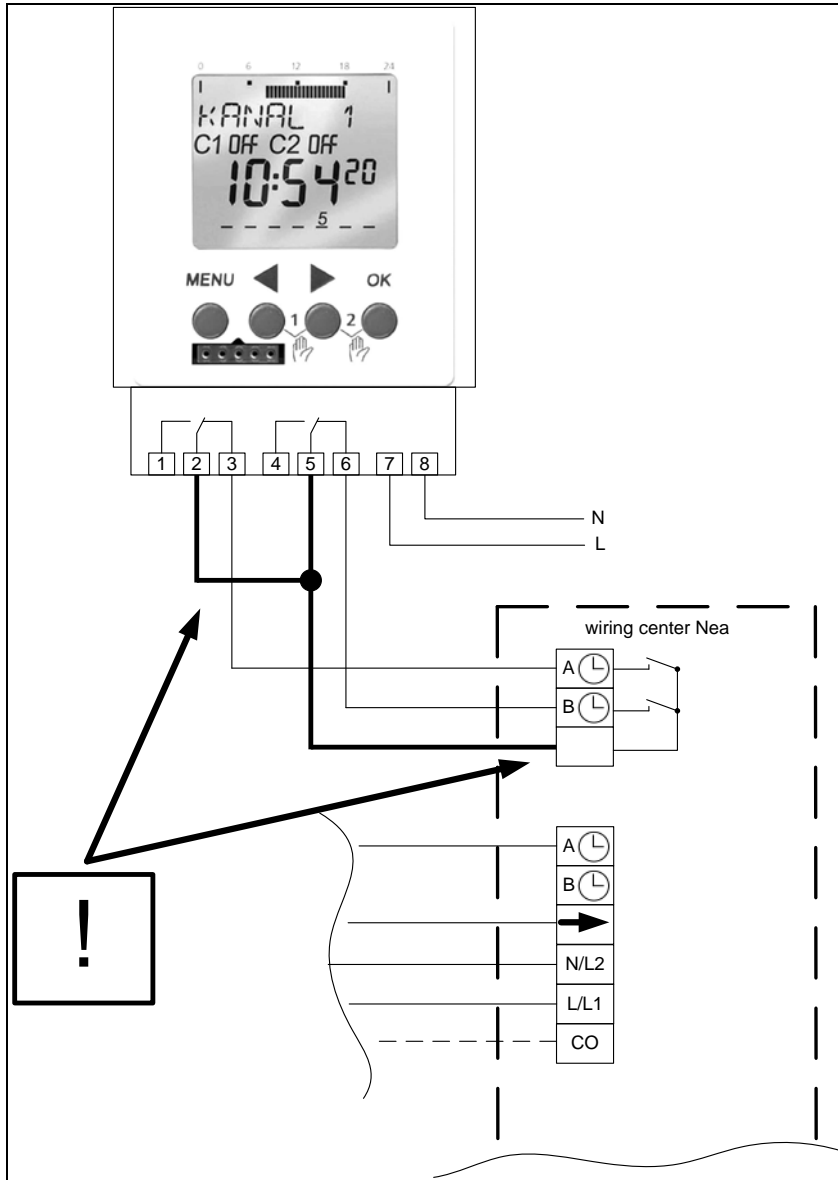

Fig. 3-7 Wiring of NEA timer to NEA wiring centre



Please note that it is absolutely required to connect terminals 2 and 5 of NEA timer to the wiring centre in the shown way!

When terminals 3 and 6 of NEA timer are used, programming of the timer has to be done in such a way, that time periods with **normal mode** are ON, the time periods with **reduced mode** are OFF.

The shown connection method is valid for all types of NEA wiring centres.



# SERVICE-MANUAL

## NEA ROOM CONTROLLER 230V / 24V

### 3.8 Wiring of a pump to NEA wiring centres with pump module

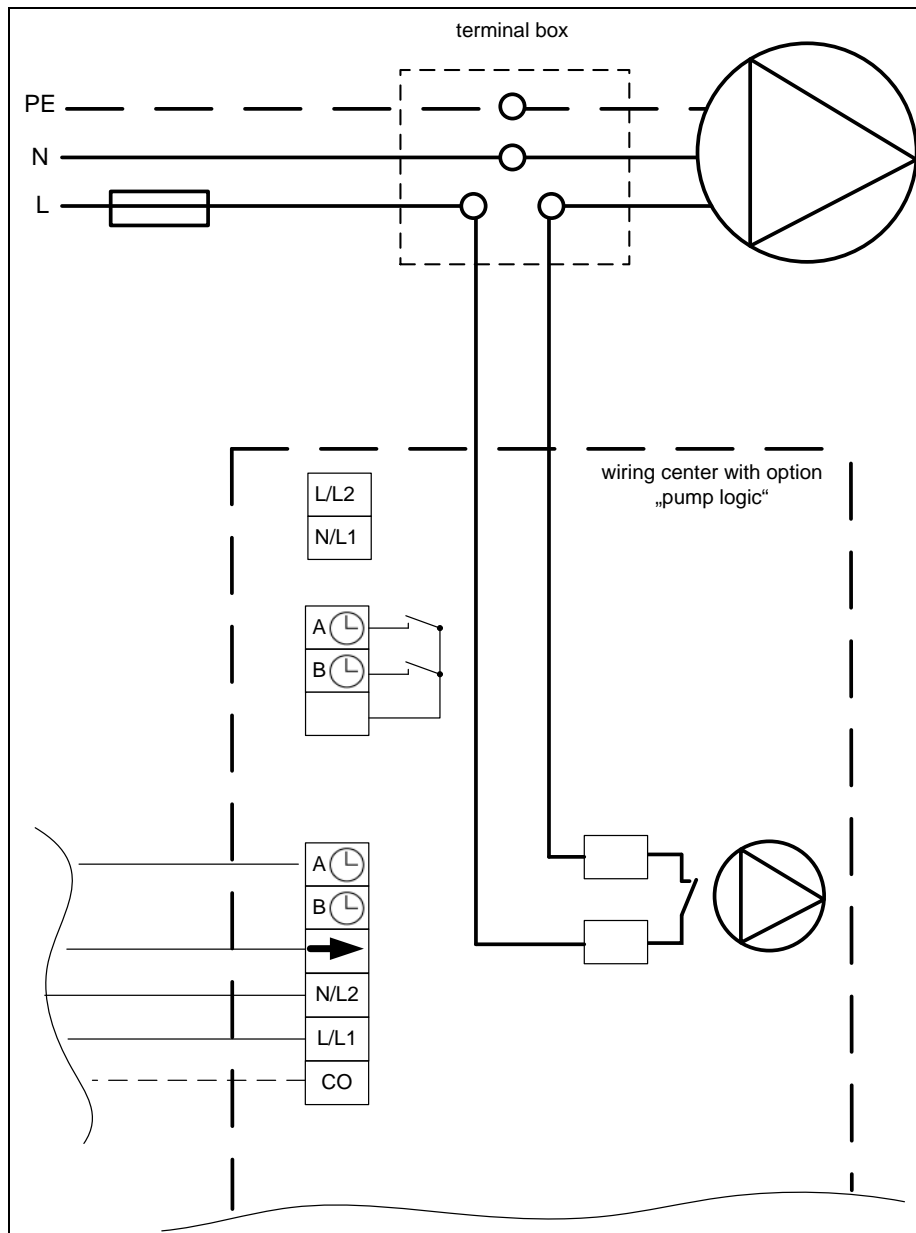

Fig. 3-8 Wiring of a pump to NEA wiring centre with pump module



By connecting live mains voltage for pump supply to the wiring centre an external voltage is brought inside the wiring centre! Note the maximum switching capacity of the pump relay in the wiring centre (5A 230 V AC, 1 A 24 V DC).

The shown connection method is valid for all types of NEA wiring centres with option "pump module".

# SERVICE-MANUAL

## NEA ROOM CONTROLLER 230V / 24V

---

### 4. Parameterisation and special functions

#### 4.1 Introduction

All parameters of the NEA room controllers are preset with values which are suitable for most applications. If necessary to customise the parameterisation, please proceed carefully and note down all changes.

You also have the possibility to reset all parameters and settings back to the factory settings by using parameter PE25.

#### 4.2 Operating in service and expert level

##### Access:

- Activate display light by pressing any key and wait 2 seconds
- Press key  $\boxed{+}$  and key  $\boxed{-}$  for about 5 seconds simultaneously, until software version occurs

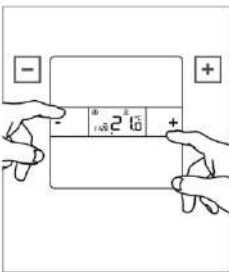

- Press Enter/Exit – key on the side

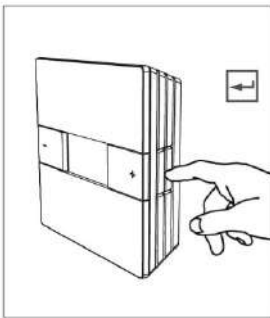

- Enter password "111" for service level or "314" for expert level using  $\boxed{+}$  and  $\boxed{-}$  - key
- Press Enter/Exit – key on the side to confirm

##### Navigation / change of parameters in service / expert-level:

- Navigate through list of parameters by using  $\boxed{+}$  and  $\boxed{-}$  key
  - Select parameter to be changed with Enter/Exit key on the side
  - The value to be changed flashes
  - Value can be changed within the input limits using the  $\boxed{+}$  and  $\boxed{-}$  keys
  - Confirm the value with Enter/Exit key on the side
  - Leave service or expert level by pressing quickly Enter/Exit key twice (double click)
-

# SERVICE-MANUAL

## NEA ROOM CONTROLLER 230V / 24V

### 4.3 Service level

Access with password **111**

Parameter	Description	Comment	Default	Min.-value	Max.-value	NEA H	NEA HT	NEA HCT
PS01	Enable set point change	Defines whether temperature set point can be changed by control buttons	ON	OFF	ON	✓	✓	✓
PS02	Enable change of operating mode	Defines whether operating mode (normal/reduced/time switch programme/Off) can be changed by control buttons	ON	OFF	ON	✓	✓	✓
PS03	Enable OFF-mode	Defines whether the controller can be set to OFF-mode	OFF	OFF	ON	✓	✓	✓
PS04	Enable Party / presence - function	0: Party/presence-function blocked 1: presence-function enabled 2: Party function with free choice of duration enabled 3: Party function with choice between 30, 60, 90, 120, ...300 minutes enabled, preset 60 min	2	0	3		✓	✓
PS05	Enable change of time switch programme	Defines whether the preset timing programme is allowed to be changed	ON	OFF	ON		✓	✓
PS06	Enable clock setting	Defines whether clock can be set	ON	OFF	ON		✓	✓
PS07	Enable date setting	Defines whether date can be set	ON	OFF	ON		✓	✓
PS08	Enable holiday mode	Defines whether holiday function can be enabled	ON	OFF	ON		✓	✓
PS09	Activation key lock	Keys are locked after 30 min. (lock is shown on display when any key is pressed). See note *1) how to release keys temporarily	OFF	OFF	ON	✓	✓	✓
PS10	Temperature unit (°C/F)	ON: Display in °C OFF: Display in Fahrenheit	ON	OFF	ON	✓	✓	✓
PS11	Clock format (24h/12h)	ON: 24h – Format OFF: 12h – Format (AM / PM)	ON	OFF	ON		✓	✓
PS12	Display light mode	0: Off 1: permanent on 2: Auto: on by key press, automatic switch off with delay	2	0	2	✓	✓	✓

\*1) Press all 3 keys at the same time for about 3 seconds, enter password 410

Key lock will be overruled for 30 mins, in this timeframe parameter PS09 can be set back

# SERVICE-MANUAL

## NEA ROOM CONTROLLER 230V / 24V

Parameter	Description	Comment	Default	Min.-value	Max.-value	NEA H	NEA HT	NEA HCT
PS13	Automatic acceptance of changed values	ON: Changed values will be accepted, when Enter/Exit Key is pressed <b>and</b> after 5 sec. OFF: Changed values will be accepted only, when Enter/Exit Key is pressed. If not, the input will be cancelled.	ON	OFF	ON	✓	✓	✓
PS14	Set point heating reduced mode	Room temp. set point for heating mode in reduced mode [°C]	18	0	37	✓	✓	✓
PS15	Set point heating normal mode	Room temp. set point for heating mode in normal mode [°C]	22	0	37	✓	✓	✓
PS16	Set point cooling normal mode	Room temp. set point for cooling mode in normal mode [°C]	24	0	37			✓
PS17	Set point cooling reduced mode	Room temp. set point for cooling mode in reduced mode [°C]	26	0	37			✓
PS18	Resolution of set point and actual value reading	0: values will be displayed with 1K reading 1: 0,5K reading 2: 0,1K reading	1	0	2	✓	✓	✓
PS19	Calibration of internal temperature probe	Offset value for internal room temperature probe	0K	-5K	+5K	✓	✓	✓
PS20	Calibration of external temperature probe	Offset value for external temperature probe / floor temperature probe	0K	-5K	+5K			✓
PS21	Actual value of external temperature probe	Display of actual temperature value from external temperature probe	-	0°C	50°C			✓
PS22	State of switching output	The state of switching output for actuator is shown (ON/OFF). Comment: The state of output is also displayed in end user level with the "heating" or "cooling" symbol.	-	OFF	ON	✓	✓	✓
PS23	Number of connected actuators	Only 24V controllers: Number of actuators directly connected to switching output	1	1	5	✓	✓	✓

# SERVICE-MANUAL

## NEA ROOM CONTROLLER 230V / 24V

### 4.4 Expert level

Access with password **314**

Parameter	Description	Comment	Default	Min.-value	Max.-value	NEA H	NEA HT	NEA HCT
PE01	Minimum value for set point heating	Minimum value for set point heating selectable in user level [°C]	16	6	37	✓	✓	✓
PE02	Maximum value for set point heating	Maximum value for set point heating selectable in user level [°C]	24	6	37	✓	✓	✓
PE03	Minimum value for set point cooling	Minimum value for set point cooling selectable in user level [°C]	18	6	37			✓
PE04	Maximum value for set point cooling	Maximum value for set point cooling selectable in user level [°C]	30	6	37			✓
PE05	Proportional band width heating mode	Width of proportional band for room temperature control in heating mode [K] <i>See also section 7</i>	4	0,5	8	✓	✓	✓
PE06	Proportional band width cooling mode	Width of proportional band for room temperature control in cooling mode [K] <i>See also section 7</i>	4	0,5	8			✓
PE07	Cycle time of PWM-signal	Cycle time of Puls-Width-Modulating output signal of room temperature control in minutes. <i>See also section 7</i>	20	6	60	✓	✓	✓
PE08	Position of proportional band	PWM-signal in % when temperature set point is achieved. This defines the position of the proportional band and at the same time the needed heating/cooling power when the set point is reached. <i>See also section 7</i>	50	10	90	✓	✓	✓
PE09	Enable Heating/Cooling	0: heating mode only enabled 1: cooling mode only enabled 2: Heating and cooling mode enabled	2	0	2			✓
PE10	Enable change heating/cooling mode	1: Switch over between heating/cooling <b>only by input keys</b> 2: Switch over between heating/cooling <b>only by CO input signal</b>	2	1	2			✓
PE11	Delay time after switching heating/cooling	After switching operation mode from heating to cooling or reverse the output signal will be blocked for this time span [min]. The new operating mode starts to be active after this time.	15	0	60			✓

# SERVICE-MANUAL

## NEA ROOM CONTROLLER 230V / 24V

Parameter	Description	Comment	Default	Min.-value	Max.-value	NEA H	NEA HT	NEA HCT
PE12	Enable optimisation function	The control behaviour will be adapted to the room temperature conditions in certain time periods <i>See also section 7</i>	ON	OFF	ON	✓	✓	✓
PE13	Enable start optimisation	The start of the heat up phase after reduced mode will be optimised. <i>See also section 7</i>	OFF	OFF	ON	✓	✓	✓
PE14	Room temperature set point in holiday mode	Room temperature set point in holiday mode. This set point is only valid in heating mode, during holiday mode cooling function is blocked	12	0	37		✓	✓
PE15	Enable frost protection	Enables the frost protection function. The frost protection function of the controller will be activated e.g. in operating mode "OFF". When frost protection is activated, error message with code "Fr" is displayed.	ON	OFF	ON	✓	✓	✓
PE16	Enable valve exercise	The output signal for the actuator is activated once per week for 5 min.	ON	OFF	ON	✓	✓	✓
PE17	Function of external temperature probe	0: not connected 1: floor temperature probe for minimum and maximum value monitoring (minimum value valid for cooling, maximum value for heating) 2: floor temperature probe for minimum and maximum value monitoring (minimum value valid for cooling <b>and heating</b> , maximum value for heating) 3: External room temperature probe (room temperature control <b>only by this value</b> ) 4: External floor temperature probe (floor temperature control) 5: External room temperature probe (room temperature control <b>by mean value of external and internal probe</b> )	0	1	5			✓
PE18	Lower limit floor temperature	Lower limit of floor temperature, valid when PE17=1 (cooling mode will be stopped) and PE17=2 (cooling mode will be stopped, in heating mode floor temperature will not fall below this value).	20	6	37			✓
PE19	Upper limit floor temperature	Upper limit of floor temperature, valid when PE17=1 and 2 (in heating mode floor temperature will not exceed this value).	30	6	37			✓

# SERVICE-MANUAL

## NEA ROOM CONTROLLER 230V / 24V

Parameter	Description	Comment	Default	Min.-value	Max.-value	NEA H	NEA HT	NEA HCT
PE20	Enable automatic mode / external control	0: Automatic mode blocked 1: Enable internal time switch programme 2: Enable control by time switch input 3: Enable internal time switch programme and external signal (external signal "reduced mode" overwrites in operating mode "Automatic" the internal time switch programme)	3	0	3	✓	✓	✓
PE21	Type of connected actuators (NC/NO)	ON: Actuators normally opened (NO) OFF: Actuators normally closed (NC)	OFF	OFF	ON	✓	✓	✓
PE22	Enable daylight saving time	ON: Automatic switching to daylight saving time OFF: No daylight saving time	ON	OFF	ON		✓	✓
PE23	Start of daylight saving time	Hour, week of month and month of switching to daylight saving time. Format hh.ww.mm (The input is done in 3 sequential screens) <i>Comment:</i> <i>Week 5 means, that the last Sunday of the month is selected</i>	02 05 03	00 01 01	23 5 12		✓	✓
PE24	End of daylight saving time	hour, week of month and month of switching back to normal time Format hh.ww.mm (The input is done in 3 sequential screens) <i>Comment:</i> <i>Week 5 indicates, that the last Sunday of the month is selected</i>	03 05 10	00 01 01	23 5 12		✓	✓
PE25	Reset to factory settings	After selecting YES all default settings are loaded and the controller restarts	NO	NO	YES	✓	✓	✓

# SERVICE-MANUAL



## NEA ROOM CONTROLLER 230V / 24V

---

### 4.5 Special functions

#### Display of output state

The state and effect of the output for the actuator is monitored on the controller display by the

symbols  and :

 Output is active, controller is heating

 Output is active, controller is cooling







The state of the output is also shown in parameter PS22.

#### Switching between heating and cooling mode using input keys

The switching between operation modes heating and cooling is normally triggered (parameter PE10) by the provided CO input. This ensures that all controllers follow the demand "heating" or "cooling" by a super ordinate system or operation.

If this method is not possible due to the existing cabling situation manual, switching is possible after changing parameter PE10 to the value

1: Open operating mode selection by pressing Enter/Exit key

- Scroll with  and  keys until display shows HC
- Select HC by pressing Enter/Exit key
- Select symbol  for heating or  for cooling using  and  keys
- Confirm with Enter/Exit key

#### Key lock

Key lock is activated by parameter PS09 (set parameter to ON).

After setting parameter to ON there is a delay time of 30 min, until key lock is activated.

After activation of key lock function all keys are locked and whenever a key is pressed, the display shows a lock symbol for 1 second.

Temporarily cancellation of keys locks:

- Press all keys at the same time for about 5 sec
- Input of password is demanded
- Enter password 410 and confirm

After this keys are released for 30 mins. During this time changes of set points or similar actions can be done.

Resumption of key lock is done automatically after 30 mins.

If permanent removal of key lock is wanted during this time parameter PS09 can be reset.

#### Connection of more than 1 actuators to NEA 24 V controller

If more than 1 actuator is connected to a NEA 24 V controller the number of actuators has to be inserted in parameter PS23 (only NEA 24V).



# SERVICE-MANUAL

## NEA ROOM CONTROLLER 230V / 24V

---

### 5. Error messages

No	Description	Comment	Action
Fr	Frost protection	Frost protection function has been activated because room temperature is below +5°C	Ensure heating, possibly close windows
Er1	Remote temperature probe out of range	Measured value is out of allowed range from -30 to 50°C	Check probe and cabling
Er2	Interruption of remote temperature probe	Probe defective or cable interrupted	Check probe and cabling
Er3	Short circuit of remote temperature probe	Probe defective or short circuit on cable	Check probe and cabling
Er4	Room temperature probe out of range	Measured value is out of allowed range from -30 to 50°C	Check whether controller is disposed to improper temperature influences, Replace controller NEA
Er5	Interruption of room temperature probe	Internal probe defective	Replace controller NEA
Er6	Short circuit of room temperature probe	Internal probe defective	Replace controller NEA

# SERVICE-MANUAL

## NEA ROOM CONTROLLER 230V / 24V

### 6. Troubleshooting

No	Problem	Cause	Action
1	Room temperature set point cannot be achieved (heating)	Temperature of heating medium too low	Increase flow temperature
		Flow rate of heating circuits too low	Check hydraulic balancing
		Actuator defective, wrongly assigned or improper connection	Increase room temperature set point to maximum value; check whether actuator opens the valve. Check cabling.
		Optimisation function is not working correct	Check parameter PE12. Note: Optimisation function needs some time.
2	Room temperature set point cannot be achieved (cooling)	If configured: measured value of floor temperature probe above upper limit	Check whether displayed value (PS21) and set point is realistic. Maybe the floor temperature probe is located in an area, where heat distribution is low (e.g. below a carpet).
		Temperature of cooling medium too high	Check control of flow temperature
		Flow rate of cooling circuits too low	Check hydraulic balancing
		Cooling power systemic not sufficient	Check whether additional cooling is possible, using shading system
3	Room temperature almost always too high (heating)	If configured: measured value of floor temperature probe below lower limit	Check whether displayed value (PS21) and set point is realistic. Maybe the floor temperature probe is located in an area, where heat absorption is low (e.g. below a carpet).
		Actuator defective, wrongly assigned or incorrectly connected	Decrease room temperature set point to minimum value; check whether actuator opens the valve. Check cabling.
		Temperature of heating medium too high	Reduce flow temperature
4	Room temperature is oscillating	Heat/cooling power not constant	Check entire system
		Improper parameterisation of NEA controller	Increase width of proportional band (PE05 or PE06) <i>see section 7, proportional band</i>  Check setting of cycle time, reduce possibly (PE07)
5	Floor temperature too low in cooling mode	Flow temperature too low	Check system
		If configured: measured value of floor temperature probe above lower limit	Check whether displayed value (PS21) and set point is realistic.

# SERVICE-MANUAL

## NEA ROOM CONTROLLER 230V / 24V

---

Nr	Problem	Cause	Action
6	In cooling mode condensation occurs on manifolds and cooled surfaces	Flow temperature below dew point	Check flow temperature control, air humidity measurement. Increase safety distance of flow temperature to measured dew point. Install dew point monitor.
		Heavy fluctuating air humidity	Increase safety distance of flow temperature to measured dew point.
		Dew point monitor without function	Check function and cabling of dew point monitor
7	No display lighting	Display light deactivated	Check parameter PS12
		Controller not energised	Check fuse in controller or wiring centre

# SERVICE-MANUAL

## ROOM TEMPERATURE CONTROLLER NEA 230V / 24V

### 7. Glossary

#### Monitoring of floor temperature

Floor temperature monitoring by NEA HCT is done by using an optional external temperature probe, used as a floor temperature probe (PE17 = 1 or 2).

The limits are fixed in parameters PE18 and PE19.

PE17=1: the lower limit of the floor temperature is only considered in cooling mode; the cooling is stopped when the limit is reached.

PE17=2 the lower limit of the floor temperature is also considered in heating mode; heating is done in any case until the configured limit is reached.

#### CO signal

The CO signal (change over) indicates the change from heating mode to cooling mode. It is generated by a superordinated control system or device, e.g. a heat pump.

A potential free contact is needed for the connection of the signal to the wiring centre.

#### Optimisation function

The optimisation function of the controller checks periodically whether the room temperature is below or above the set point. Thereafter an adaption of the control behaviour follows, only in small steps. Due to this the result of the optimisation can only be seen after a longer time frame.

#### Proportional band

The proportional band – better said the width and the position – characterises the control behaviour of a proportional controller. The output signal of the controller descends from 100% beginning from one end of the proportional band to 0% on the other end of the proportional band.

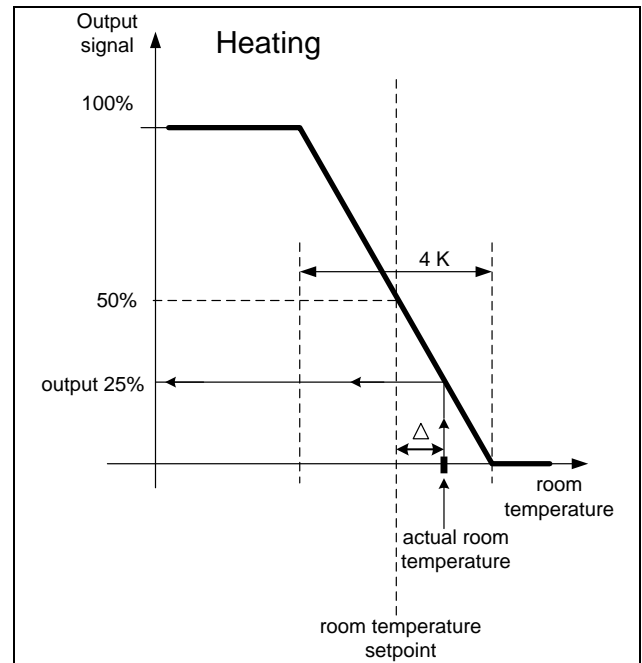

The diagram shows the working principle of a proportional controller (P-controller) in heating mode. The width of the proportional band is 4K, the output signal at set point is as predefined in parameter PE08 50%.

The actual room temperature is approx. 1K above set point, the output signal is approx. 25%.

# SERVICE-MANUAL

## NEA ROOM CONTROLLER 230V / 24V

The diagram below shows the situation with the same room temperature set point and the same actual value, only with modified parameter PE08: 75%

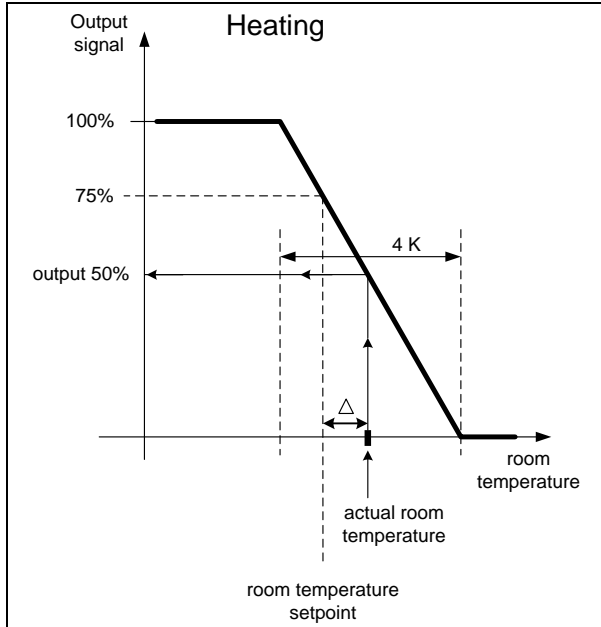

Above is the result of the controller output signal at 50%.

The diagram below shows the effect when the width of the proportional band is reduced (PE05: 2K). Under otherwise constant conditions the output signal is reduced to 25%.

Because of this the controller has a stronger response to a deviation from set point when the width of the proportional band is reduced.

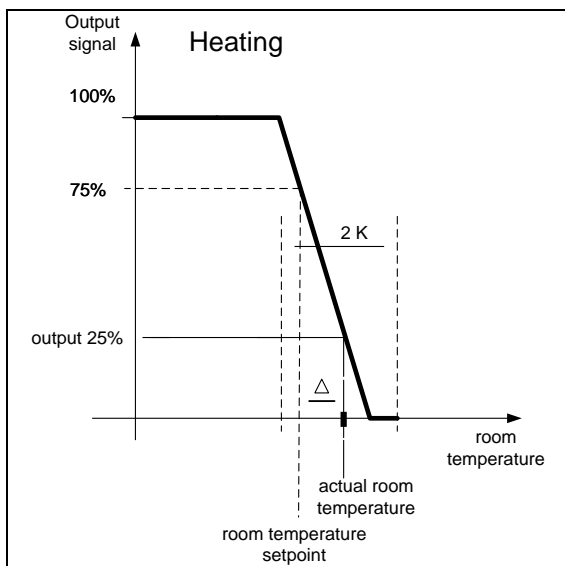

### Phase coincidence

If more than 1 NEA wiring centre is used in a building and it is planned to switch the controllers by a common signal to reduced mode, it is not allowed to connect the wiring centre with the existing plug to mains. In this case the connection to mains must be done in a fixed way.

In this case it has to be noted that all wiring centres are connected to the same live phase.

Because in buildings with 3-phase AC supply the 3 phases are split up in different parts of the building, for the room temperature control system, a common power supply has to be used.

### Pulse width modulation (PWM)

Pulse Width Modulation (PWM) is the conversion of an analogue, continuous signal (e.g. a control signal 0... 100%) to a sequence of pulses with a fixed cycle time. The length of the pulses is proportional to the control signal.

In this way the control signal of a continuous controller is converted to a 2-point control signal (On/Off).

Due to the inertia of surface heating systems there is, despite the switching on and off, a continuous temperature trend.

The diagram below shows a sequence of pulses corresponding to a control signal of 50%.

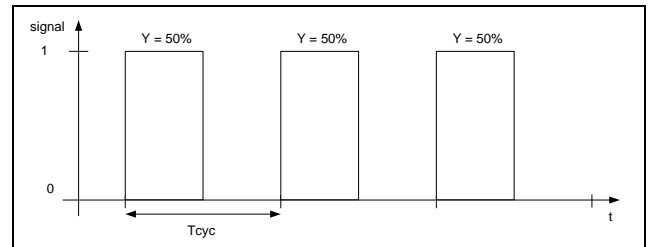

In the 2nd example the control signal rises starting from 50% to 75% and then 90%.

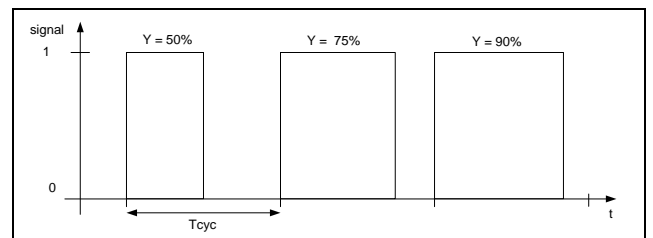

# SERVICE-MANUAL

## NEA ROOM CONTROLLER 230V / 24V

---

### **Pump logic**

The pump logic ensures that the pump relay is switched on as soon as one of the room temperature controllers switches on the valve actuator.

Therefore the pump is only activated when there is a real need to heat or cool.

### **Reduced operating mode**

Reduced operating mode is the activation of a room temperature set point – triggered by a time switch programme or manually – which causes reduced energy consumption.

In well insulated buildings however, the temperature goes down very slowly when heating power is reduced.

On the other hand it is a fact that – if the heating power is well adapted to the energy demand of the building – during heat up phase the temperature rises very slowly.

Because of this the suitable set point for reduced mode has to be chosen, in well insulated buildings a set back value of 2K is appropriate.

The same applies for the cooling mode, whereas effective cooling power is often lower than heating power.

### **Valve exercise**

Valves which are not activated for a long time might stick.

To prevent this, switch on the valve actuator once a week for 5 minutes when the valve exercise (PE16) is enabled.

---

# SERVICE-MANUAL

## NEA ROOM CONTROLLER 230V / 24V

Insofar as the intended application deviates from that described in the relevant Technical Information brochure, the user must consult REHAU and must receive express written consent from REHAU before commencing this utilization. If the user fails to do so, the sole responsibility for the utilization shall lie with the individual user. In this case, the application, use and processing of products are beyond our control. Should a case of liability arise, however, this shall be limited to the value of the goods delivered by us and used by you in all cases of damage. Claims arising from granted guarantees shall become invalid in the case of intended applications that are not described in the Technical Information brochures.

This document is protected by copyright. All rights based on this are reserved. No part of this publication may be translated, reproduced or transmitted in any form or by any similar means, electronic or mechanical, photocopying, recording or otherwise, or stored in a data retrieval system.

### REHAU SALES OFFICES

**AE: Middle East**, Phone: +9714 8935677, dubai@rehaui.com **AR: Buenos Aires**, Phone: +54 11 489860-00, buenosaires@rehaui.com **AT: Linz**, Phone: +43 732 381610-0, linz@rehaui.com **Vienna**, Phone: +43 2236 24684, wien@rehaui.com **AU: Adelaide**, Phone: +61 8 82990031, adelaide@rehaui.com **Brisbane**, Phone: +61 7 55271833, brisbane@rehaui.com **Melbourne**, Phone: +61 3 95875544, melbourne@rehaui.com **Perth**, Phone: +61 8 94564311, perth@rehaui.com **Sydney**, Phone: +61 2 87414500, sydney@rehaui.com **BA: Sarajevo**, Phone: +387 33 475-500, sarajevo@rehaui.com **BE: Brussels**, Phone: +32 16 3999-11, bruxelles@rehaui.com **BG: Sofia**, Phone: +359 2 89204-71, sofia@rehaui.com **BR: Arapongas**, Phone: +55 43 3152 2004, arapongas@rehaui.com **Belo Horizonte**, Phone: +55 31 33097737, belo Horizonte@rehaui.com **Caxias do Sul**, Phone: +55 54 32146606, caxias@rehaui.com **Mirassol**, Phone: +55 17 32535190, mirassol@rehaui.com **Recife**, 51030-320 Bairro-Boa viagem-Recife-PE, Phone: +55 81 32028100 **Sao Paulo**, Phone: +55 11 461339- 22, saopaulo@rehaui.com **BY: Minsk**, Phone: +375 17 2450209, minsk@rehaui.com **CA: Moncton**, Phone: +1 506 5382346, moncton@rehaui.com **Montreal**, Phone: +1 514 9050345, montreal@rehaui.com **St. John's**, Phone: +1 709 7473909, stjohns@rehaui.com **Toronto**, Phone: +1 905 3353284, toronto@rehaui.com **Vancouver**, Phone: +1 604 6264666, vancouver@rehaui.com **CH: Berne**, Phone: +41 31 7202-120, bern@rehaui.com **Vevey**, Phone: + 41 21 94826-36, vevey@rehaui.com **Zurich**, Phone: +41 44 83979-79, zuerich@rehaui.com **CL: Santiago**, Phone: +56 22496-1900, santiago@rehaui.com **CN: Guangzhou**, Phone: +86 20 87760343, guangzhou@rehaui.com **Beijing**, Phone: +86 10 64282956, beijing@rehaui.com **Shanghai**, Phone: +86 21 63551155, shanghai@rehaui.com **CO: Bogota**, Phone: +57 1 898-5286, bogota@rehaui.com **CZ: Prague**, Phone: +420 2 72190-111, praha@rehaui.com **DE: Berlin**, Phone: +49 30 66766-0, berlin@rehaui.com **Bielefeld**, Phone: +49 521 20840-0, bielefeld@rehaui.com **Bochum**, Phone: +49 234 68903-0, bochum@rehaui.com **Frankfurt**, Phone: +49 6074 4090-0, frankfurt@rehaui.com **Hamburg**, Phone: +49 40 733402-100, hamburg@rehaui.com **Leipzig**, Phone: +49 34292 82-0, leipzig@rehaui.com **Munich**, Phone: +49 8102 86-0, muenchen@rehaui.com **Nuremberg**, Phone: +49 9131 93408-0, nuernberg@rehaui.com **Stuttgart**, Phone: +49 7159 1601-0, stuttgart@rehaui.com **DK: Copenhagen**, Phone: +45 46 7737-00, kobenhavn@rehaui.com **EE: Tallinn**, Phone: +372 6 0258-50, tallinn@rehaui.com **ES: Barcelona**, Phone: +34 93 6353-500, barcelona@rehaui.com **Bilbao**, Phone: +34 94 45386-36, bilbao@rehaui.com **Madrid**, Phone: +34 91 6839425, madrid@rehaui.com **FI: Helsinki**, Phone: +358 9 877099-00, helsinki@rehaui.com **FR: Agen**, Phone: +33 5536958-69, agen@rehaui.com **Lyon**, Phone: +33 472026-300, lyon@rehaui.com **Metz**, Phone: +33 3870585-00, metz@rehaui.com **Paris**, Phone: +33 1 348364-50, paris@rehaui.com **GE: Tiflis**, Phone: +995 32 559909, tbilisi@rehaui.com **GB: Glasgow**, Phone: +44 1698 50 3700, glasgow@rehaui.com **Manchester**, Phone: +44 161 7777-400, manchester@rehaui.com **Slough**, Phone: +44 1753 5885-00, slough@rehaui.com **GR: Athens**, Phone: +30 210 6682-500, athens@rehaui.com **HR: Zagreb**, Phone: +385 1 3444-711, zagreb@rehaui.com **HU: Budapest**, Phone: +36 23 5307-00, budapest@rehaui.com **ID: Jakarta**, Phone: +62 21 45871030, jakarta@rehaui.com **IE: Dublin**, Phone: +353 1 816502-0, dublin@rehaui.com **IN: New Delhi**, Phone: +91 11 450 44700, newdelhi@rehaui.com **Mumbai**, Phone: +91 22 67922929, mumbai@rehaui.com **IT: Milan**, Phone: +39 02 95841-1, milano@rehaui.com **Pesaro**, Phone: +39 0721 2006-11, pesaro@rehaui.com **Rome**, Phone: +39 06 900613-11, roma@rehaui.com **Treviso**, Phone: +39 0422 7265-11, treviso@rehaui.com **KZ: Almaty**, Phone: +7 727 394 1304, almaty@rehaui.com **LT: Vilnius**, Phone: +370 210 2461-00, vilnius@rehaui.com **LV: Riga**, Phone: +371 67 609080, riga@rehaui.com **MA: Casablanca**, Phone: +212 522 250593, casablanca@rehaui.com **MK: Skopje**, Phone: +389 2402-670, skopje@rehaui.com **MX: Celaya**, Phone: +52 461 61880-00, celaya@rehaui.com **Monterrey**, Phone: +52 81 81210-130, monterrey@rehaui.com **NL: Nijkerk**, Phone: +31 33 24799-11, nijkerk@rehaui.com **NO: Oslo**, Phone: +47 22 5141-50, oslo@rehaui.com **NZ: Auckland**, Phone: +64 9 2722264, auckland@rehaui.com **PE: Lima**, Phone: +51 1 2261713, lima@rehaui.com **PL: Katowice**, Phone: +48 32 7755-100, katowice@rehaui.com **Poznan**, Phone: +48 61 849-8400, poznan@rehaui.com **Warsaw**, Phone: +48 22 2056-300, warszawa@rehaui.com **PO: Lisbon**, Phone: +351 21 94972-20, lisboa@rehaui.com **RO: Bacau**, Phone: +40 234 512066, bacau@rehaui.com **Bucharest**, Phone: +40 21 2665180, buciuresti@rehaui.com **Cluj**, Phone: +40 264 415211, clujnapoca@rehaui.com **RU: Chabarowsk**, Phone: +7 4212 411218, chabarowsk@rehaui.com **Yekaterinburg**, Phone: +7 343 2535305, jekatarinburg@rehaui.com **Krasnodar**, Phone: +7 861 2103636, krasnodar@rehaui.com **Moscow**, Phone: +7 495 6632060, moscow@rehaui.com **Nizhny Novgorod**, Phone: +7813 786927, nischnijnowgorod@rehaui.com **Novosibirsk**, Phone: +7 383 2000353, novosibirsk@rehaui.com **Rostov-on-Don**, Phone: +7 8632 978444, rostow@rehaui.com **Samara**, Phone: +7 8462 698058, samara@rehaui.com **St. Petersburg**, Phone: +7 812 3266207, stpetersburg@rehaui.com **RS: Belgrade**, Phone: +381 11 3770-301, beograd@rehaui.com **SE: Örebro**, Phone: +46 19 2064-00, oerebro@rehaui.com **SG: Singapore**, Phone: +65 63926006, singapore@rehaui.com **SK: Bratislava**, Phone: +421 2 682091-10, bratislava@rehaui.com **TH: Bangkok**, Phone: +66 2 7443155, bangkok@rehaui.com **TR: Istanbul**, Phone: +90 212 35547-00, istanbul@rehaui.com **TW: Taipei**, Phone: +886 2 87803999, taipei@rehaui.com **UA: Dnepropetrovsk**, Phone: +380 56 3705028, dnepropetrovsk@rehaui.com **Kiev**, Phone: +380 44 4677710, kiev@rehaui.com **LViv**, Phone: +380 32 2244810, lviv@rehaui.com **Odessa**, Phone: +380 48 7800708, odessa@rehaui.com **US: Detroit**, Phone: +1 248 8489100, detroit@rehaui.com **Grand Rapids**, Phone: +1 616 2856867, grandrapids@rehaui.com **Los Angeles**, Phone: +1 951 5499017, losangeles@rehaui.com **Minneapolis**, Phone: +1 612 253 0576, minneapolis@rehaui.com **ZA: Durban**, Phone: +27 31 657447, durban@rehaui.com **Johannesburg**, Phone: +27 11 201-1300, johannesburg@rehaui.com. If there is no sales office in your country please contact: REHAU AG + Co, Sales Office International Business Development, Ytterbium 4, D-91058 Erlangen, Phone: +49 9131 92-5888, salesoffice.ibd@rehaui.com